

Article number: 439500120

Description: Rota-fix shaft-hub connection F120x165
Steel

Note: Self centering. Very high torque

Measures

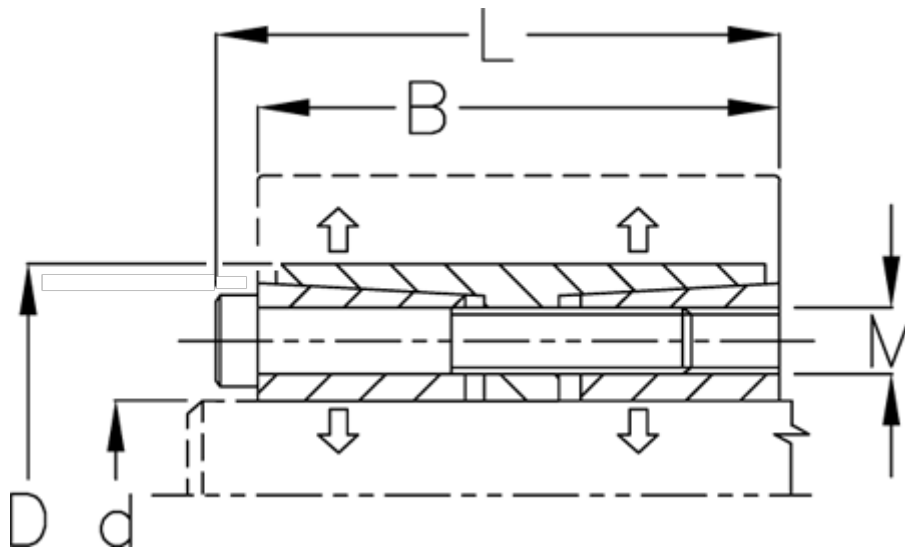

B mm	= 98
d H8 mm	= 120
D mm	= 165
Fit tolerance	= Aksel h8, Nav H8
F kN torque	= 600.0
L mm	= 110
M mm	= M12
P N/mm ² surface pressure on shaft/hub	= 110

Surface roughness	= R? ? 3.2 µm
T N m torque	= 36500
Ts N m bolt tightening torque	= 145.0